



Husqvarna®



K 4000

EN	Operator's manual	2-25
FR	Manuel d'utilisation	26-50
NL	Gebruiksaanwijzing	51-75
DE	Bedienungsanweisung	76-101

Contents

INTRODUCTION.....	2	MAINTENANCE.....	20
SAFETY.....	4	TRANSPORTATION, STORAGE AND DISPOSAL.....	22
ASSEMBLY.....	9	TECHNICAL DATA.....	23
OPERATION.....	14	EC DECLARATION OF CONFORMITY.....	25

INTRODUCTION

Owner responsibility

It is the owner's/employer's responsibility that the operator has sufficient knowledge about how to use the product safely. Supervisors and operators must have read and understood the Operator's Manual. They must be aware of:

- The products's safety instructions.
- The products's range of applications and limitations.
- How the product is to be used and maintained.

National legislation could regulate the use of this product. Find out what legislation is applicable in the place where you work before you start using the product.

Product description

K 4000 is a high speed handheld power cutter designed to cut hard materials like masonry or steel. It should not be used for any purpose not described in this manual. Safe operation of this product requires the operator to read this manual carefully. Ask your dealer or Husqvarna if you need more information.

Design and features

Features

K 4000 is made with innovative technology for high performance and reliability, and provides advanced technical solutions and environmental considerations.

Some of the unique features of K 4000 are described below.

Elgard™

Elgard™ is an electronic overload protection that protects the motor. The protection spares the machine and extends its service life. With the help of Elgard™, the machine indicates when it approaches maximum load.

Softstart™

Softstart™ is an electronic current limiter which provides a softer start.

Vac attachment accessory (not supplied)

The Vac attachment is easily attached to the machine and connected to the vacuum cleaner / dust collector for effective dust management when dry cutting.

Intended use

This product is designed and intended for cutting tile and stone. All other use is improper.

The product is intended for use in industrial applications by experienced operators.

Product overview

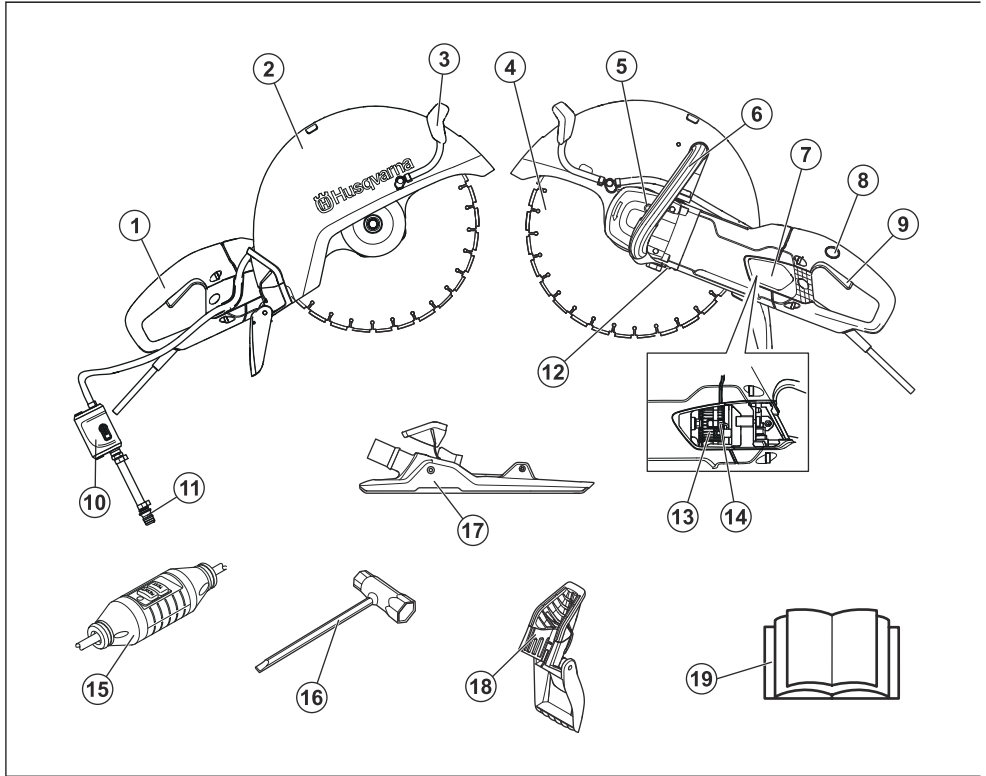

1. Rear handle
2. Blade guard
3. Water kit
4. Cutting blade (not supplied)
5. Locking the axle
6. Front handle
7. Inspection cover
8. Power switch lock
9. Power switch
10. Water tap with flow limiter
11. Water connector
12. Rating plate
13. Brush retainer
14. Carbon brushes
15. Residual-current device (not for UK and Ireland)
16. Combination spanner
17. Vac attachment (accessory, not supplied)
18. Splash guard
19. Operator's manual

Symbols on the product



WARNING! The product can be a dangerous tool if used incorrectly or carelessly, which can cause serious or fatal injury to the operator or others.



Please read the operator's manual carefully and make sure you understand the instructions before using the product.



Wear personal protective equipment. See *Personal protective equipment on page 7* for instructions.



This product is in accordance with applicable EC directives.



WARNING! Dust forms when cutting, this can cause injuries if inhaled. Use an approved breathing mask. Avoid inhaling exhaust fumes. Always provide for good ventilation.



WARNING! Sparks from the cutting blade can cause fire in combustible materials such as: petrol (gas), wood, clothes, dry grass, etc.



WARNING! Kickbacks can be sudden, rapid and violent and can cause life threatening injuries. Read and understand the instructions in the manual before using the product.



WARNING! Ensure the blades are not cracked or damaged in any other way.



WARNING! Do not use circular saw blades.

Note: Other symbols/decals on the product refer to special certification requirements for certain markets.

Type plate

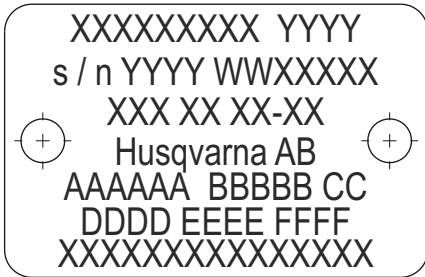

Row 1: Brand, Model (X, Y)

Row 2: Serial No. with manufacturing date (Y, W, X):
 Year, Week, Sequence No.

Row 3: Product No (X)

Row 4: Manufacturer

Row 5: A: Max. speed of output shaft, B: Cutting blade diameter, C: Blade bolt diameter

Row 6: D: Input voltage, E: Input current, F: Input frequency

Row 7: Country of origin

Product liability

As referred to in the product liability laws, we are not liable for damages that our product causes if:

- the product is incorrectly repaired.
- the product is repaired with parts that are not from the manufacturer or not approved by the manufacturer.
- the product has an accessory that is not from the manufacturer or not approved by the manufacturer.
- the product is not repaired at an approved service center or by an approved authority.

SAFETY

Safety definitions

Warnings, cautions and notes are used to point out specially important parts of the operator's manual.



WARNING: Used if there is a risk of injury or death for the operator or bystanders if the instructions in the manual are not obeyed.



CAUTION: Used if there is a risk of damage to the product and/or the attachment, other materials or the adjacent area if the instructions in the manual are not obeyed.

Note: Used to give more information that is necessary in a given situation.

General safety instructions

It is not possible to cover every conceivable situation you might be exposed to. Always exercise care and use your common sense. If you get into a situation where you feel unsafe, stop and seek expert advice. Contact your dealer, service agent or an experienced user. Do not attempt any task that you feel unsure of!

Note: Save all warnings and instructions for future reference.



WARNING: Read all safety warnings and all instructions.



WARNING: Never use a product that has faulty safety equipment! If your product fails any checks contact your service agent to get it repaired.



WARNING: Please read the operator's manual carefully and make sure you understand the instructions before using the product. It is recommended that first time operators also obtain practical instruction before using the product.



WARNING: Keep in mind that it is you, the operator that is responsible for not exposing people or their property to accidents or hazards.



WARNING: The product must be kept clean. Signs and stickers must be fully legible.



WARNING: The product can be a dangerous tool if used incorrectly or carelessly, which can cause serious or fatal injury to the operator or others.



WARNING: Never allow children or other persons not trained in the use of the product to use or service it.



WARNING: The product is not intended for use by persons (including children) with reduced physical, sensory or mental capabilities, or lack of experience and knowledge.



WARNING: Never allow anyone else to use the product without first ensuring that they have read and understood the contents of the operator's manual.



WARNING: Never use the product if you are fatigued, while under the influence of alcohol or drugs, medication or anything that could affect your vision, alertness, coordination or judgement.



WARNING: Unauthorized modifications and/or accessories may lead to serious injury or death to the user or others. Under no circumstances may the design of the product be modified without the permission of the manufacturer.



WARNING: Do not modify this product or use it if it appears to have been modified by others.



WARNING: Never use a product that is faulty. Carry out the safety checks, maintenance and service instructions described in this manual. Some maintenance and service measures must be carried out by trained and qualified specialists. See *MAINTENANCE on page 20* for instructions.



WARNING: Always use genuine accessories.



WARNING: This product produces an electromagnetic field during operation. This field may under some circumstances interfere with active or passive medical implants. To reduce the risk of serious or fatal injury, we recommend persons with medical implants to consult their physician and the medical implant manufacturer before operating this product.

Safety instructions for assembly



WARNING: Read the following warning instructions carefully before using the product.



WARNING: Never use a cutting blade for any other materials than what it was intended to cut.



WARNING: Never use a diamond blade to cut plastic material. The heat produced during cutting may melt the plastic and it can stick to the cutting blade and cause a kickback.



WARNING: Diamond blades become very hot when used. An overheated blade is a result of improper use, and may cause deformation of the blade, resulting in damage and injuries.



WARNING: A cutting blade may burst and cause injury to the operator.



WARNING: The cutting blade manufacturer issues warnings and recommendations for the use and proper care of the cutting blade. Those warnings come with the cutting blade. Read and follow all instructions from the cutting blade manufacturer.



WARNING: A cutting blade should be checked before it is assembled on the saw and frequently during use. Look for cracks, lost segments (diamond blades) or pieces broken off. Do not use a damaged cutting blade.



WARNING: Test the integrity of each new cutting blade by running it at full throttle for about 1 minute.



WARNING: Never use a cutting blade with a lower speed rating than that of the power cutter. Only use cutting blades intended for handheld high speed power cutters.



WARNING: Do not use abrasive blades with water. The strength is impaired when abrasive blades are exposed to water or moisture, which results in an increased risk of the blade breaking.



WARNING: Use only blades which are in compliance with national or regional standards/regulations, for example EN 13236 or EN 12413 or ANSI B7.1.



WARNING: Cutting metal generates sparks that may cause fire. Do not use the machine near ignitable substances or gases.



WARNING: Cutting metal is not allowed with the Vac attachment.



WARNING: Never use toothed blades such as wood cutting blades, circular toothed blades, carbide tipped blades, etc. The risk

of kickback is significantly increased and tips can be torn off and thrown at high speed. Carelessness can result in serious personal injury or even death.



WARNING: Government regulation requires a different type of guarding for carbide tipped blades not available on power cutters – a 360 degree guard. Power Cutters (this saw) use Abrasive or Diamond blades and have a different guarding system which does not provide protection against the dangers presented by wood cutting blades.

Note: Cutting with abrasive discs is not allowed with the Vac attachment. Use of abrasive discs causes unnatural wear on the Vac attachment.

Safety instructions for operation

Work area safety



WARNING: The safety distance for the power cutter is 15 metres (50 foot). You are responsible to ensure that animals and onlookers are not within the working area. Do not start cutting until the working area is clear and you are standing firmly.

- Keep work area clean and well lit.
- Do not operate power tools in explosive atmospheres, such as in the presence of flammable liquids, gases or dust.
- Keep children and bystanders away while operating a power tool.
- Observe your surroundings to ensure that nothing can affect your control of the product.
- Ensure that no persons or objects can come into contact with the cutting equipment or be hit by parts thrown by the blade.
- Do not use the product in bad weather, such as dense fog, heavy rain, strong wind, intense cold, etc. Working in bad weather is tiring and can lead to dangerous conditions, such as slippery surfaces.
- Never start to work with the product before the working area is clear and you have a firm foothold. Look out for any obstacles with unexpected movement.
- Ensure when cutting that no material can become loose and fall, causing injury to the operator. Take great care when working on sloping ground.
- Ensure that the working area is sufficiently illuminated to create a safe working environment.
- Make sure that no pipes or electrical cables are routed in the working area or in the material to be cut.

- If cutting into a container (drum, pipe, or other container) you must first make sure it does not contain flammable or other volatile material.

Electrical safety



WARNING: The product (United Kingdom and Ireland 110V) is not equipped with a ground fault circuit interrupter. The machine must always be used with an isolating transformer for protection in case an electrical fault should occur.



WARNING: Do not wash the machine with water, as water can enter the electrical system or the engine and cause damage to the machine or short circuit.

- **Power tool plugs must match the outlet. Never modify the plug in any way. Do not use any adapter plugs with earthed (grounded) power tools.** Unmodified plugs and matching outlets will reduce the risk of electric shock.
- **Avoid body contact with earthed or grounded surfaces, such as pipes, radiators, ranges and refrigerators.** There is an increased risk of electric shock if your body is earthed or grounded.
- **Do not expose the power tool to rain or wet conditions.** Water entering a power tool will increase the risk of electric shock.
- **Do not abuse the cord. Never use the cord for carrying, pulling or unplugging the power tool. Keep cord away from heat, oil, sharp edges or moving parts.** Damaged or entangled cords increase the risk of electric shock.
- **When operating a power tool outdoors, use an extension cord suitable for outdoor use.** Use of a cord suitable for outdoor use reduces the risk of electric shock.
- **If operating a power tool in a damp location is unavoidable, use a residual current device (RCD) protected device. Use of an RCD reduces the risk of electric shock.**
- Check that the cord and extension cord are intact and in good condition. Never use the machine if the cord is damaged, hand it in to an authorized service workshop for repair.
- To avoid overheating do not use the extension cord while it is rolled up.
- When using an extension cable, use only certified extension cables with sufficient reach. For more information, see *Technical data on page 23* section. An undersized cable means a risk of reduced machine capacity and overheating.
- The machine should be connected to an earthed outlet socket. Check that the mains voltage corresponds with that stated on the rating plate on the machine.
- Ensure the cord is behind you when you start to use the machine so that the cord will not be damaged.

Personal safety

- **Stay alert, watch what you are doing and use common sense when operating a power tool. Do not use a power tool while you are tired or under the influence of drugs, alcohol or medication.** A moment of inattention while operating power tools may result in serious personal injury.
- **Use personal protective equipment. Always wear eye protection.** Protective equipment such as a dust mask, non-skid safety shoes, hard hat, or hearing protection used for appropriate conditions will reduce personal injuries.
- Avoid accidental starting. Ensure that the switch is in the OFF-position before plugging in.
- **Prevent unintentional starting. Ensure the switch is in the OFF-position before connecting to power source and/or battery pack, picking up or carrying the tool.** Carrying power tools with your finger on the switch or energising power tools that have the switch on, can result in accidents.
- **Remove any adjusting key or wrench before turning the power tool on.** A wrench or a key left attached to a rotating part of the power tool may result in personal injury.
- **Do not overreach. Keep proper footing and balance at all times.** This enables better control of the power tool in unexpected situations.
- **Dress properly. Do not wear loose clothing or jewellery. Keep your hair, clothing and gloves away from moving parts.** Loose clothes, jewellery or long hair can be caught in moving parts.
- **If devices are provided for the connection of dust extraction and collection facilities, ensure these are connected and properly used.** Dust collection can reduce dust-related hazards.
- Remain at a distance from the blades when the engine is running.
- Overexposure to vibration can lead to circulatory damage or nerve damage in people who have impaired circulation. Contact your doctor if you experience symptoms of overexposure to vibration. Such symptoms include numbness, loss of feeling, tingling, pricking, pain, loss of strength, changes in skin colour or condition. These symptoms normally appear in the fingers, hands or wrists. These symptoms may be increased in cold temperatures.

Personal protective equipment



WARNING: Products such as cutters, grinders or drills, that sand or form material can generate dust and vapors, which may contain hazardous chemicals. Check the nature of the material you intend to process and use an appropriate breathing mask.



WARNING: Always use approved hearing protection. Long-term exposure to noise can result in permanent hearing impairment. Be

aware of warning signals or shouts when you are wearing hearing protection. Always remove your hearing protection as soon as the motor stops.



WARNING: There is always a risk of crush injuries when working with products containing moving parts. Wear protective gloves to avoid body injuries.



WARNING: Sparks may appear and start a fire when you work with the product. Always keep fire fighting equipment handy.

You must use approved personal protective equipment when you use the product. Personal protective equipment cannot eliminate the risk of injury but it will reduce the degree of injury if an accident does happen. Ask your dealer for help in choosing the right equipment.

Always wear:

- Approved protecting helmet.
- Hearing protection.
- Approved eye protection. If you use a face shield then you must also wear approved protective goggles. Approved protective goggles must comply with standard ANSI Z87.1 in the USA or EN 166 in EU countries. Visors must comply with standard EN 1731.
- Approved respiratory protection.
- Protective gloves.
- Heavy-duty, firm grip gloves.
- Tight-fitting, heavy-duty and comfortable clothing that permits full freedom of movement. Cutting generates sparks that can ignite clothing. Husqvarna recommends that you wear flame-retardant cotton or heavy denim. Do not wear clothing made of material such as nylon, polyester or rayon. If ignited such material can melt and cling to the skin. Do not wear shorts.
- Boots with steel toe-caps and non-slip sole.

Always have a first aid kit and firefighting equipment nearby.

Safety devices on the product



WARNING: Read the following warning instructions carefully before using the product.

Power switch

Press the power switch to start the power cutter and release the switch stop the power cutter.

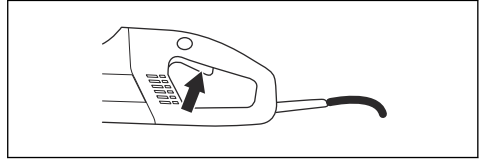

Power switch lock

The power switch lock is designed to prevent accidental operation of the switch. Press the power lock switch (A) to release the power switch (B).

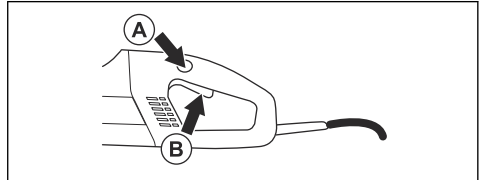

The power switch lock remains released as long as the power switch is released. When the grip on the handle is released both the power switch and power switch lock are reset. This movement is controlled by two independent return springs. This position results in the machine stopping and the power switch being locked.

Blade guard

This guard is fitted above the cutting blade and is designed to prevent parts of the blade or cutting fragments from being thrown towards the user.

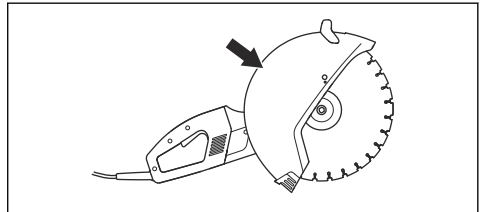

Residual-current device

Ground fault circuit interrupters are for protection in case an electrical fault should occur.

The LED indicates that the ground fault circuit interrupter is on and that the machine can be switched on. If the LED is not on, push the RESET button (green).

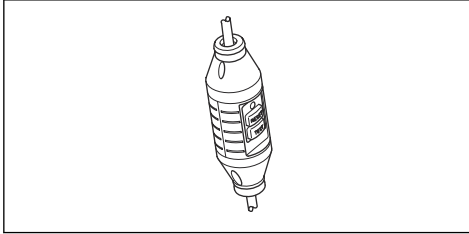

Safety instructions for maintenance



WARNING: The user must only carry out the maintenance and service work described in this Operator's Manual. More extensive work



must be carried out by an authorized service workshop.

WARNING: The engine should be switched off, and the stop switch in STOP position.



WARNING: Wear personal protective equipment. See *Personal protective equipment on page 7*.



WARNING: The lifespan of the product can be reduced and the risk of accidents can increase if product maintenance is not carried out correctly and if service and/or repairs are not carried out professionally. If you need further information please contact your nearest service workshop.



CAUTION: Let your Husqvarna dealer regularly check the product and make essential adjustments and repairs.

ASSEMBLY

Cutting blades

Husqvarna blades are high speed blades approved for hand held power cutters.

- Cutting blades are available in two basic designs: abrasive blades and diamond blades.

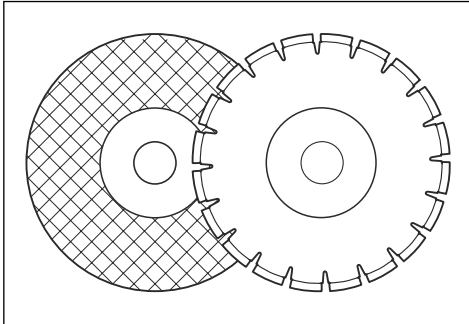

- High-quality blades are often most economical.
- Lower quality blades often have inferior cutting capacity and a shorter service life, which results in a higher cost in relation to the quantity of material that is cut.
- Make sure that the right bushing is used for the cutting blade to be fitted on the product. For instructions, see *To fit the cutting blade on page 13*.

Suitable cutting blades

Cutting blades	K 4000	K 4000 with a Vac attachment
Abrasive blades	Yes*	No
Diamond blades	Yes	Yes
Toothed blades	No	No

*Without water.

For more information, see *Technical data on page 23*.

Cutting blades for different material



WARNING: Never use a cutting blade for any other materials than what it was intended to cut.



WARNING: Never use a diamond blade to cut plastic material. The heat produced during cutting may melt the plastic and it can stick to the cutting blade and cause a kickback.



WARNING: Cutting metal generates sparks that may cause fire. Do not use the product near ignitable substances or gases.



WARNING: Cutting metal is not allowed with the Vac attachment.

- Follow the instructions supplied with the cutting blade concerning the suitability of the blade for various applications or consult your dealer.

	Concrete	Metal	Plastic	Cast iron
Abrasive blades*	X	X*	X	X
Diamond blades	X	X**	---	X**

*Only without the Vac attachment.

**Only specialty blades. Only without the Vac attachment.

Cutting blades for handheld high speed power cutters



WARNING: Never use a cutting blade with a lower speed rating than that of the power cutter. Only use cutting blades that are in compliance with national or regional standards, for example EN 13236 or EN 12413 or ANSI B7.1.

- Many cutting blades that might fit this power cutter are intended for stationary saws and have a lower speed rating than what is needed for this handheld power cutter. Cutting blades with a lower speed rating shall never be used on this power cutter.
- Husqvarna cutting blades are manufactured for high speed, portable power cutters.
- Check that the blade is approved for the same or higher speed according to the approval plate of the engine.

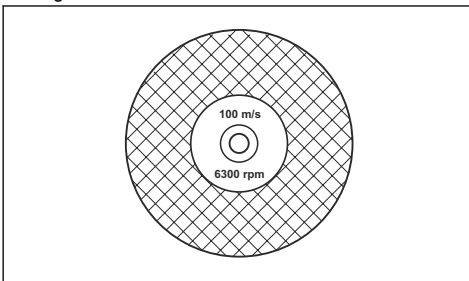

Blade vibration

- The blade can become out-of-round and vibrate if an excessive feed pressure is used.
- A lower feed pressure can stop the vibration. Otherwise replace the blade.

Abrasive blades



WARNING: Do not use abrasive blades with water. The strength is impaired when abrasive blades are exposed to water or moisture, which results in an increased risk of the blade breaking.



CAUTION: Cutting with abrasive blade is not allowed with the Vac attachment. Use of abrasive blades causes unnatural wear on the Vac attachment.

- Do not use worn reinforced wheels from larger power tools. Wheels intended for a larger power tool are not suitable for the higher speed of a smaller tool and may burst.
- The cutting material on abrasive blades consists of a grit bonded agent using an organic binder. Reinforced blades are made up of a fabric or fibre base that prevents total breakage at maximum working speed if the blade should be cracked or damaged.
- A cutting blade's performance is determined by the type and size of abrasive corn, and the type and hardness of the bonding agent.
- Ensure the cutting blade is not cracked or damaged.

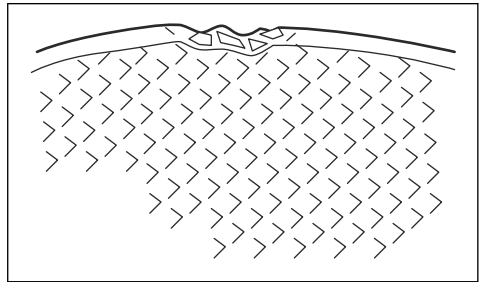

- Test the abrasive blade by hanging it on your finger and tapping it lightly with a screwdriver or the like. If the blade does not produce a resonant, ringing sound it is damaged.

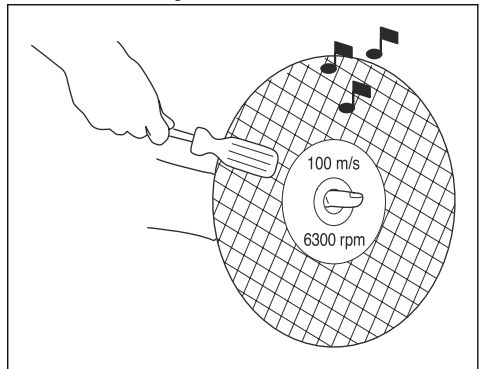

- Ensure that correct abrasive blade is used on the intended material.

Blade type	Material
Concrete	Concrete, asphalt, stone masonry, cast iron, aluminium, copper, brass, cables, rubber, plastic, etc.
Metal	Steel, steel alloys and other hard metals.

Diamond blades



WARNING: Never use a diamond blade to cut plastic material. The heat produced during cutting may melt the plastic and it can stick to the cutting blade and cause a kickback.



WARNING: Diamond blades become very hot when used. An overheated blade is a result of improper use, and may cause deformation of the blade, resulting in damage and injuries.



WARNING: Cutting metal generates sparks that may cause fire. Do not use the product near ignitable substances or gases.

Note: Diamond blades are available in several hardness classes.

Note: Sharpen the blade by cutting soft material such as sandstone or block.

- Always use a sharp diamond blade.
- Diamond blades can become dull when the wrong feeding pressure is used or when cutting certain materials such as heavily reinforced concrete. Working with a dull diamond blade causes overheating, which can result in the diamond segments coming loose.
- Diamond blades consist of a steel core provided with segments that contain industrial diamonds.
- Diamond blades are ideal for masonry, reinforced concrete and other composite materials.
- Diamond blades ensure lower costs per cutting operation, fewer blade changes and a constant cutting depth.
- Special blades should be used when cutting metal. Ask your dealer for help in choosing the right product.
- When using diamond blade make sure that it rotates in the direction indicated by the arrow on the blade.

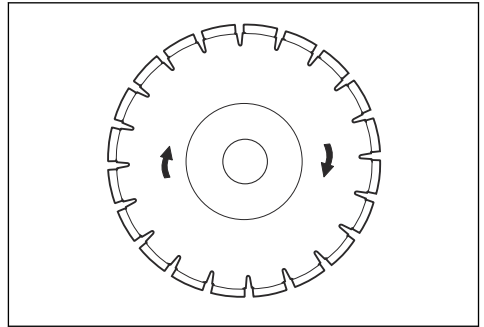

Diamond blades for dry cutting

- Diamond blades for dry cutting can be used both with and without water cooling.
- When dry cutting, lift the blade out from the cut every 30–60 seconds and let it rotate in the air for 10 seconds to let it cool. If this is not done, the blade will become overheated.

Diamond blades for wet cutting

Note: Do not use Vac attachment when wet cutting. Wet concrete sludge considerably reduces the suction capacity of the Vac attachment.

- Diamond blades for wet cutting must be water cooled. If this is not done, the blade may be overheated.
- Water cools the blade and increases its service life while also reducing the formation of dust.
- Water cooling, which is used when cutting concrete, cools the blade and increases its service life while also reducing the formation of dust. Disadvantages include difficulties at very low temperatures, the risk of damaging floors and other structural elements, and the risk of slipping.

Diamond blade - side clearance



WARNING: Check that the diamond segment (T1) is wider than the blade core (T2) to prevent binding in the cutting slot and a kickback.

Replace the blade before it is completely worn out.



CAUTION: Certain cutting situations or poor blades may cause excessive wear on the side of the segments.

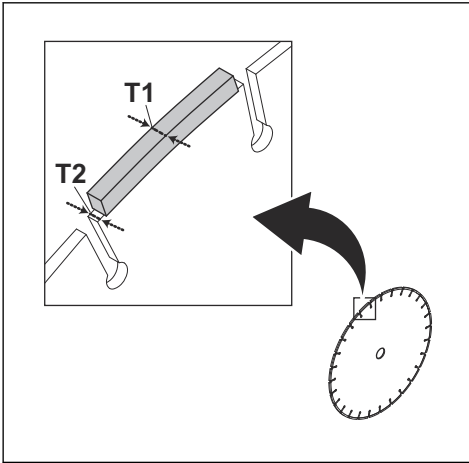

Some Husqvarna blades are available with side clearance wear indicators to help determine a blade's lifespan.

Toothed blades



WARNING: Never use toothed blades such as wood cutting blades, circular toothed blades, carbide tipped blades, etc. The risk of kickback is significantly increased and tips can be torn off and thrown at high speed. Carelessness can result in serious personal injury or even death.



WARNING: Government regulation requires a different type of guarding for carbide tipped blades not available on power cutters – a 360 degree guard. Power Cutters (this saw) use abrasive or diamond blades and have a different guarding system which does not provide protection against the dangers presented by wood cutting blades.

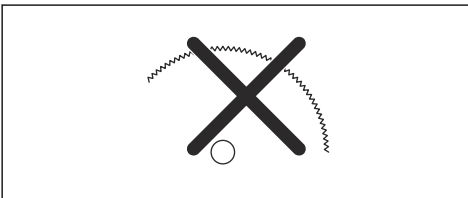

Use of this power cutter with a carbide tipped blade is a violation of work safety regulations.

Due to the hazardous nature and exigent circumstances involved with fire fighting and rescue operations conducted by the various highly trained public safety forces, safety professionals (fire departments), Husqvarna is aware that they may use this power cutter

with carbide tipped blades in certain emergency situations due to the ability of carbide tipped blades to cut many different types of obstructions and materials in combination without having to take time to switch blades or machines. When using this power cutter be aware at all times that carbide tipped blades are more kickback prone than abrasive or diamond blades if not used properly. Carbide tipped blades can also throw pieces of material away from the blade.

For these reasons, a power cutter equipped with a carbide tipped blade should never be used except by highly trained public safety professionals who are aware of the risks associated with its use and then only in those exigent circumstances when other tools are deemed inefficient and ineffective for fire or rescue operations. A power cutter equipped with a carbide tipped blade should never be used to cut wood in non-rescue operations.

To examine the spindle shaft and flange washers

Examine the flange washers and the spindle shaft when the blade is replaced.



CAUTION: Use only flange washers supplied by Husqvarna with minimum diameter 105mm/4.1in.



CAUTION: Do not use warped, notched, indented or dirty flange washers.



CAUTION: Do not use different dimensions of flange washers.

1. Make sure that the threads on the spindle shaft are undamaged.
2. Make sure that the contact surfaces on the blade and the flange washers are undamaged, of the correct dimension, clean, and that they run properly on the spindle shaft.

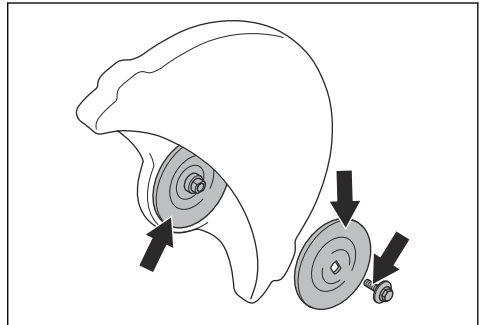

To examine the arbor bushing

Make sure the arbor bushings fit to the centre hole on the cutting blade.

The product is supplied with either a fixed bushing or a bushing that can be flipped over to fit either 20 mm or 1 in (25,4 mm) center holes.

- Make sure the bushing on the spindle shaft of the product corresponds with the centre hole on the cutting blade.

The blades are marked with the diameter of the centre hole.

To examine the direction of the cutting blade rotation

If a diamond blade is used, make sure that it rotates in the direction indicated by the arrow on the blade.

- Examine the direction of the cutting blade rotation shown by the arrows on the cutting arm.

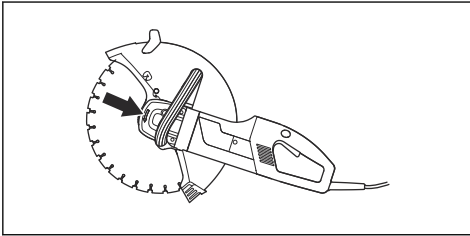

To fit the cutting blade

The tightening torque for the bolt holding the cutting blade is 25Nm (18,5ft-lbs).

The cutting blade is placed on the bushing (A) between the inner flange washer (B) and the flange washer (C). The flange washer is turned so that it fits on the axel.

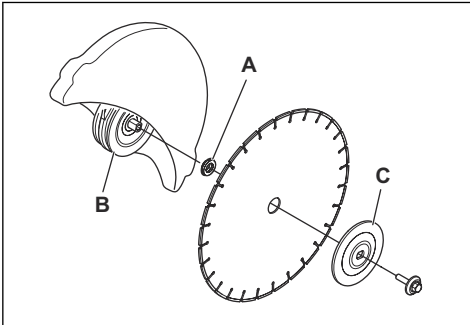

1. Lock the cutting blade/axel with the locking button on the rear of the machine. The button is reset when released.

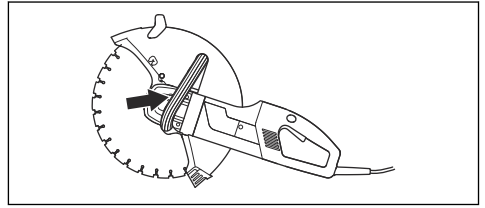

To adjust the blade guard



WARNING: Always make sure that the blade guard is correctly fitted before starting the product.

The guard for the cutting equipment should be adjusted so that the rear section is flush with the work piece.

Spatter and sparks from the cut material are then collected by the guard and moved away from the user.

The blade guard is friction locked.

1. Press the ends of the guard against the work piece or adjust the guard with the adjustment handle.

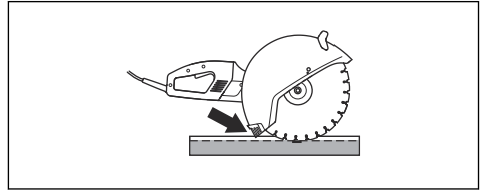

To adjust the splash guard

1. Slide the splash guard into the slots at the back of the protective cover on the cutting blade.

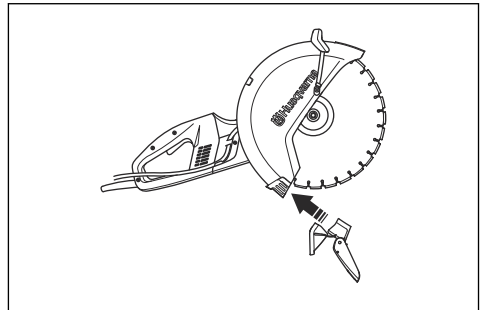

2. Make sure the locking catch rests upon the lug on the cover. Flip up the locking catch and push it against the protective cover.

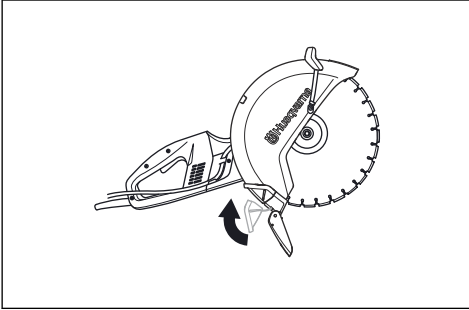

OPERATION

Basic working techniques



WARNING: Do not pull the power cutter to one side. This can cause the blade to jam or break, resulting in injury.



WARNING: Do not grind with the side of the blade. Grinding causes breaks or damage. Only use the cutting section.



WARNING: Before entering an existing slot made by another blade, check that the slot is not thinner than your blade as that may result in binding in the cutting slot and a kickback.



WARNING: Never use a diamond blade to cut plastic material. The heat produced during cutting may melt the plastic and it can stick to the cutting blade and cause a kickback.



WARNING: Cutting metal generates sparks that may cause fire. Do not use the product near ignitable substances or gases.



WARNING: Cutting metal is not allowed with the Vac attachment.

- The product is designed and intended for cutting with abrasive blades or diamond blades intended for high speed handheld products. The product shall not be used with any other type of blade, or for any other type of cutting.

- Check that the cutting blade is fitted correctly and does not show signs of damage. See *Cutting blades on page 9* for instructions.
- Check that the correct cutting blade is used for the application in question. See *Cutting blades on page 9* for instructions.
- Never cut asbestos materials!
- Hold the saw with both hands; keep a firm grip with thumbs and fingers encircling the handles. The right hand should be on the rear handle and the left hand on the front handle. All operators, whether right or left handed shall use this grip. Never operate a power cutter holding it with only one hand.

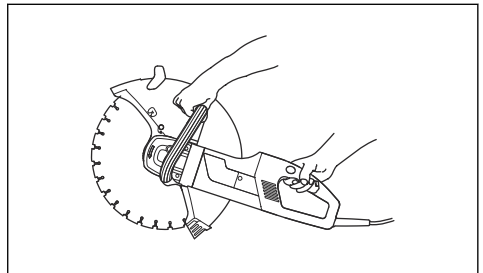

- Stand parallel to the cutting blade. Avoid standing straight behind. In the event of a kickback the saw will move in the plane of the cutting blade.

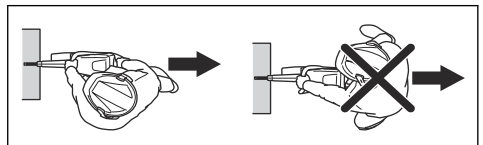

- If the blade is binding in the cut or when aborting a cut, release the throttle and wait until the blade stops. Do not extract the blade from the cut while the blade is in motion otherwise kickback may occur.

- Maintain a safe distance from the cutting blade when the engine is running. Do not try to stop a rotating blade with any part of your body.
- Never move the machine when the cutting equipment is rotating. Be sure that the blade has come to a complete stop before the machine is put on the ground.
- The guard for the cutting equipment should be adjusted so that the rear section is flush with the work piece. Spatter and sparks from the material being cut are then collected up by the guard and led away from the user. The guards for the cutting equipment must always be fitted when the product is running.

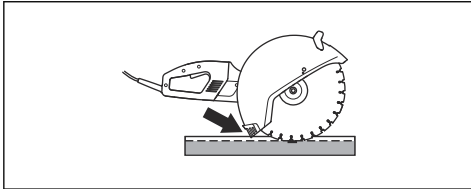

- Never use the kickback zone of the blade for cutting. See *Kickback on page 16* for instructions.
- Use extra caution when making a "pocket cut" into existing walls or other blind areas. The protruding wheel may cut gas or water pipes, electric wiring or objects that can cause kickback.
- Keep a good balance and a firm foothold.
- Never cut above shoulder height.
- Never cut from a ladder. Use a platform or scaffold if the cut is above shoulder height.

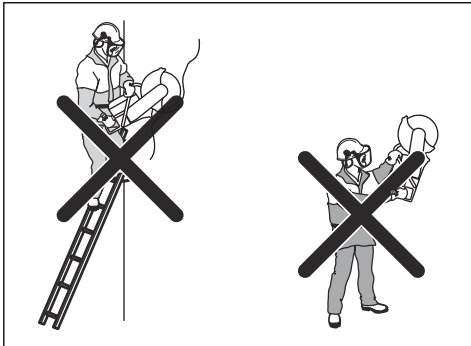

- Do not overreach.
- Stand at a comfortable distance from the work piece.
- Always ensure you have a safe and stable working position.
- Check that the blade is not in contact with anything when the product is started.
- Apply the cutting blade gently with high rotating speed (full throttle). Maintain full speed until cutting is complete.
- Let the product work without forcing or pressing the blade.

- Feed down the product in line with the blade. Pressure from the side can damage the blade and is very dangerous.

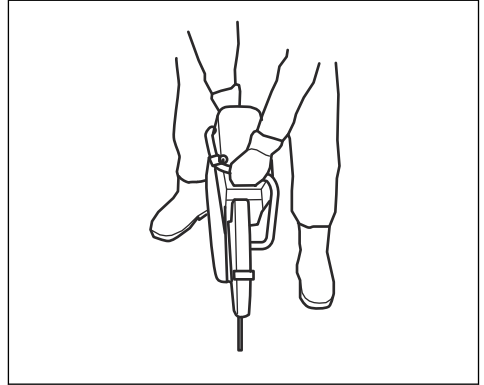

- Move the blade slowly forwards and backwards to achieve a small contact area between the blade and the material to be cut. This reduces the temperature of the blade and ensures effective cutting.

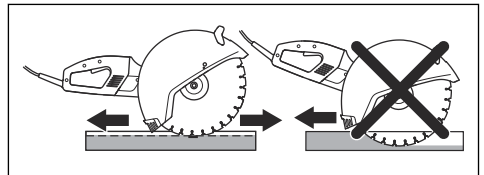

Power tool use and care

- **Do not force the power tool. Use the correct power tool for your application.** The correct power tool will do the job better and safer at the rate for which it was designed.
- **Do not use the power tool if the switch does not turn it on and off.** Any power tool that cannot be controlled with the switch is dangerous and must be repaired.
- **Disconnect the plug from the power source and/or the battery pack from the power tool before making any adjustments, changing accessories, or storing power tools.** Such preventive safety measures reduce the risk of starting the power tool accidentally.
- **Store idle power tools out of the reach of children and do not allow persons unfamiliar with the power tool or these instructions to operate the power tool.** Power tools are dangerous in the hands of untrained users.
- **Maintain power tools. Check for misalignment or binding of moving parts, breakage of parts and any other condition that may affect the power tool's operation. If damaged, have the power tool repaired before use.** Many accidents are caused by poorly maintained power tools.

- **Keep cutting tools sharp and clean.** Properly maintained cutting tools with sharp cutting edges are less likely to bind and are easier to control..
- **Use the power tool, accessories and tool bits, etc. in accordance with these instructions, taking into account the working conditions and the work to be performed.** Use of the power tool for operations different from those intended could result in a hazardous situation.
- Under no circumstances should you modify the original design of the machine without approval from the manufacturer. Always use original spare parts. Unauthorized modifications and/or accessories may lead to serious injury or death to the user or others.
- Make sure that no pipes or electrical cables are routed in the working area or in the material to be cut.
- Always check and mark out where gas pipes are routed. Cutting close to gas pipes always entails danger. Make sure that sparks are not caused when cutting in view of the risk of explosion. Remain concentrated and focused on the task. Carelessness can result in serious personal injury or death.
- The guard for the cutting equipment must always be on when the machine is running.

- A reactive force is always present when cutting. The force pulls the product in the opposite direction of the blade rotation. Most of the time this force is insignificant. If the blade is pinched or stalled the reactive force will be strong and you might not be able to control the power cutter.

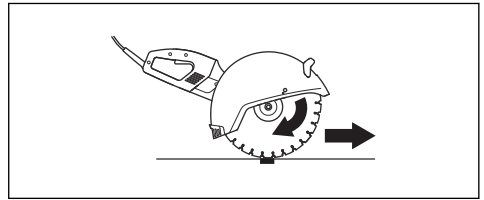

Kickback zone

- Never use the kickback zone of the blade for cutting. If the blade is pinched or stalled in the kickback zone, the reactive force will push the power cutter up and back towards the user in a rotating motion causing serious or even fatal injury.

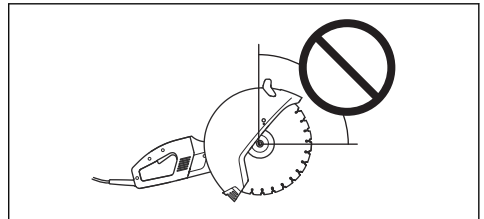

Climbing kickback

- If the kickback zone is used for cutting, the reactive force drives the blade to climb up in the cut. Do not use the kickback zone. Use the lower quadrant of the blade to avoid climbing kickback.

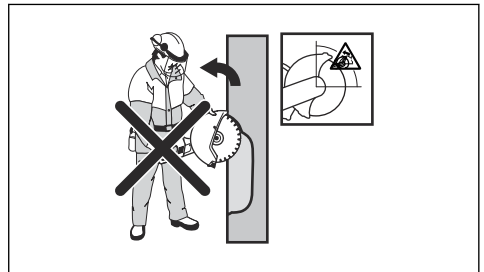

Pinching kickback

- Pinching is when the cut closes and pinches the blade. If the blade is pinched or stalled the reactive

Service

- Have your power tool serviced by a qualified repair person using only identical replacement parts. This will ensure that the safety of the power tool is maintained.

Kickback



WARNING: Kickbacks are sudden and can be very violent. The power cutter can be thrown up and back towards the user in a rotating motion causing serious or even fatal injury. It is vital to understand what causes kickback and how to avoid it before using the product.

Kickback is the sudden upward motion that can occur if the blade is pinched or stalled in the kickback zone. Most kickbacks are small and pose little danger.

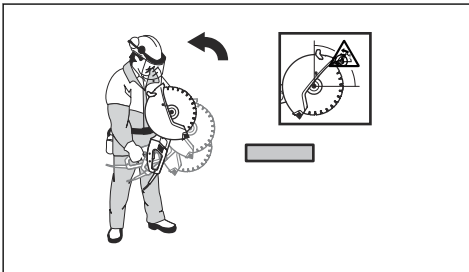

Reactive force

force will be strong and you might not be able to control the power cutter.

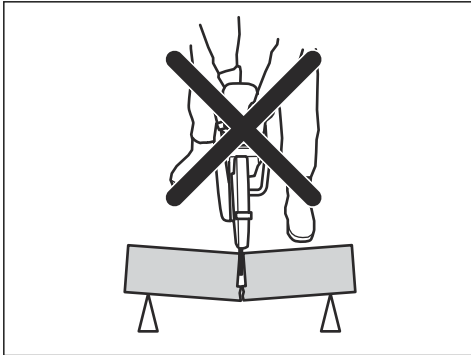

- If the blade is pinched or stalled in the kickback zone, the reactive force will push the power cutter up and back towards the user in a rotating motion causing serious or even fatal injury.

To cut in pipes



WARNING: If the blade is pinched in the kickback zone it will cause a severe kickback.



WARNING: Make sure the pipe is properly supported so that the end of the pipe moves downward when cutting.

Special care should be taken when cutting in pipes. If the pipe is not properly supported and the cut kept open throughout the cutting the blade might be pinched. Be especially alert when cutting a pipe with a belled end or a pipe in a trench that, if not properly supported, may sag and pinch the blade.

1. Secure the pipe so it does not move or roll during cutting.

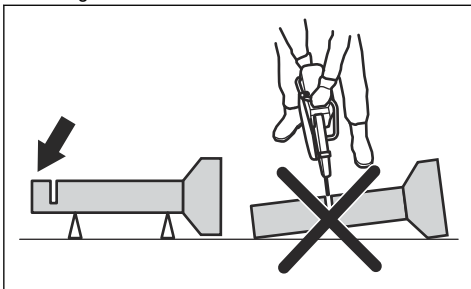

2. Cut section "I" of the pipe.

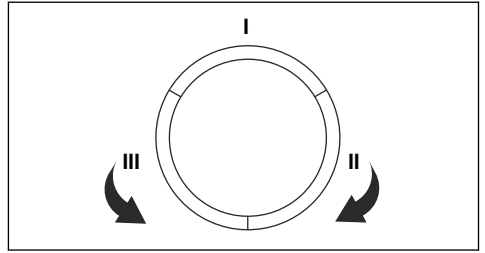

3. Ensure that the cut opens to avoid pinching.

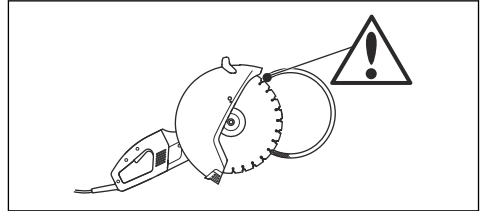

4. Move to section "II" and cut from section I to bottom of the pipe.
5. Move to section "III" and cut the remaining part of the pipe ending at the bottom.

To avoid kickback

1. Always support the work piece so that the cut can keep open when cutting through. When the cut is open, there is no kickback. If the cut is closed and pinches the blade, there is always a risk of kickback.

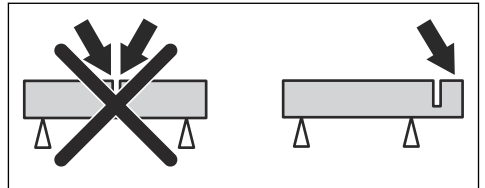

2. Be careful when you put the blade in an existing cut.

3. Be careful of the movement of the work piece or anything else that can occur. The movement or anything else could cause the cut to close and pinch the blade.

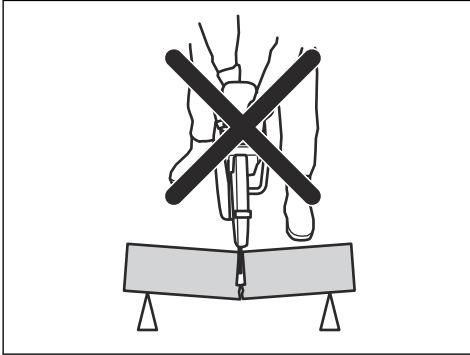

4. Do not allow the pipe to sag and close the cut. Otherwise the blade can be pinched in the kickback zone and a severe kickback can occur.
5. Properly support the end of the pipe to let it move downward, so that the cut can be open and pinching will not occur.

To examine the power switch



WARNING: A defective power switch should be replaced by an authorized service workshop.

1. Start the product and release the power switch.

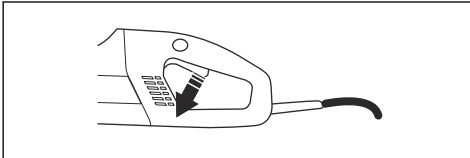

2. Make sure that the engine and the cutting blade stop.

To examine the power switch lock

1. Make sure the power switch is locked when the power switch lock is in its original position.

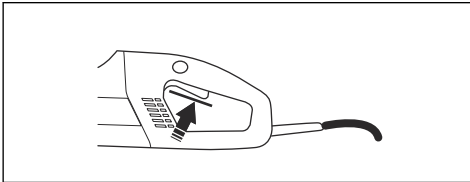

2. Press in the power switch lock and make sure it returns to its original position when you release it.

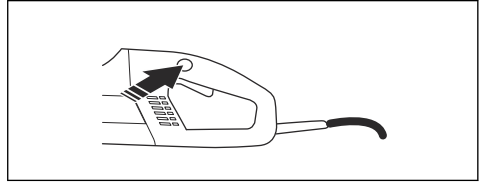

3. Make sure the power switch and power switch lock move freely and that the return springs work properly.

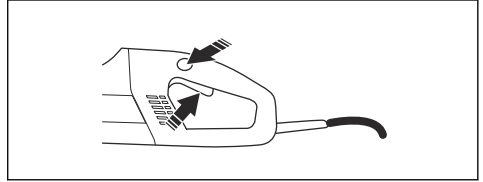

4. Start the product, release the power switch and make sure that the engine and the cutting blade stop.

To examine the blade guard



WARNING: Always make sure that the blade guard is correctly fitted before starting the product. Make sure that the cutting blade is fitted correctly and does not show signs of damage. A damaged cutting blade can cause personal injury. See instructions under the heading Assembly.

- Make sure that the guard is complete and without any cracks or deformations.

To check the residual-current device

1. Connect the machine to the socket.
2. Push the RESET button (green) and the red LED lights up.

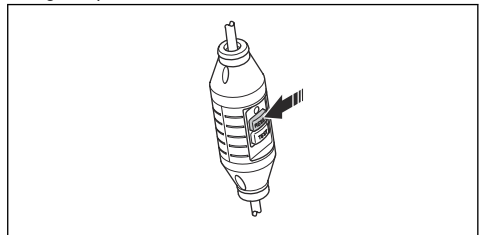

3. Start the machine.

4. Push the TEST button (blue).

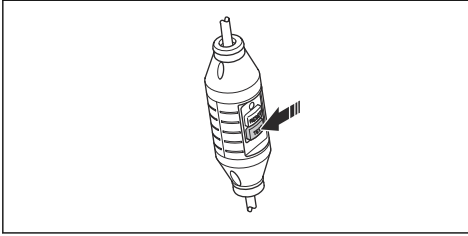

5. The ground fault circuit interrupter should trip and the machine switch off instantly. If not, contact your dealer.
6. Push the RESET button (green).

Before starting



WARNING: Please read the operator's manual carefully and make sure you understand the instructions before using the product.



WARNING: Wear personal protective equipment. See *Personal protective equipment* on page 7.



WARNING: Make sure no unapproved persons are in the working area, otherwise there is a risk of serious personal injury.



WARNING: Make sure the mains voltage agrees with the value on the rating plate on the product.

Perform daily maintenance. See section *MAINTENANCE* on page 20.

To connect water

1. Connect the water hose to the water supply (A).

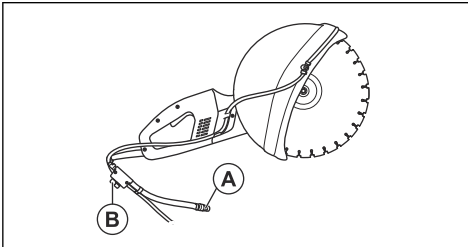

2. Turn the water tap (B) to let the water go or stop.

To switch on the ground fault circuit interrupter



WARNING: Never use the tool if the ground fault circuit interrupter is not delivered with

the tool. Carelessness can cause serious personal injury or even death.

1. Make sure the ground fault circuit interrupter is closed.

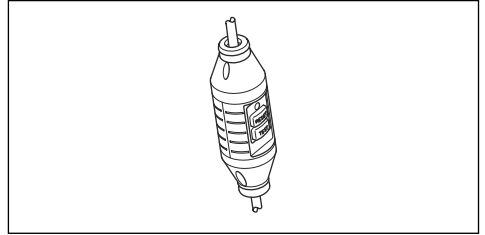

2. Start the product. If the LED is not illuminated, push the RESET button (green).
3. Examine the ground fault circuit interrupter.

To start the product

1. Hold the front handle with the left hand.
2. Hold the rear handle with the right hand.

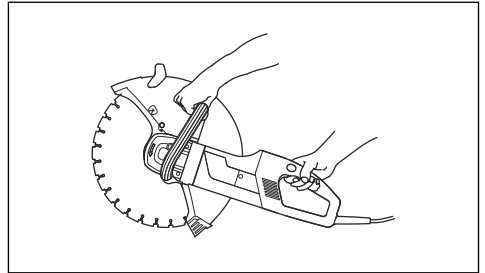

3. Push the power switch lock in with your right-hand thumb and push the power switch.

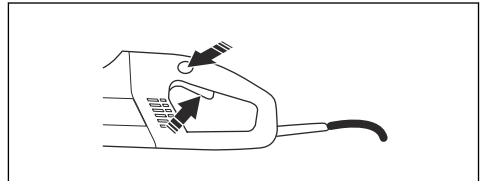

4. Operate the product without load in a safe manner for at least 30 seconds.

To stop the product



WARNING: The cutting blade continues to rotate up to a minute after the motor stops (known as blade coasting.) Make sure that the cutting blade can rotate freely until it completely stops. Carelessness can cause serious personal injury.

1. Release the power switch to stop the motor.

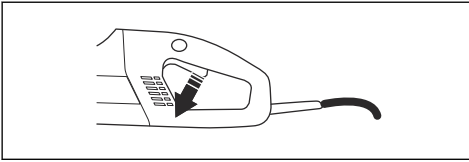

MAINTENANCE

Maintenance schedule

In the maintenance schedule you can see which parts of your product the maintenance is necessary. You can

also see with which intervals the maintenance should be done. The intervals are calculated based on daily use of the product, and may differ if the rate of usage changes.

	Daily	Weekly / 40 hours	Yearly
Cleaning	External cleaning		
	Cooling air intake		
Functional inspection	General inspection	Carbon brushes	
	Power switch*		
	Power switch lock*		
	Blade guard*		
	Cutting blade**		
	Water delivery system		
Change			Gearbox grease

*See instructions in the section *Safety devices on the product on page 8.*

** See instructions in the section *Cutting blades on page 9.*

Cleaning procedures

To do external cleaning



WARNING: Do not use a high pressure washer to flush the inner part of the product.

The product is resistant to damp air and splashes during the cutting process. When you cut materials such as concrete or brick which can contain salt, you must flush the product after the work. The cleaning reduces the risk of accretions inside the engine. The accretions inside the engine can cause leakage current between electric components. The leakage current can cause the ground fault circuit interrupter to trip accidentally.

1. Flush the product daily with clean water after the work.
2. Position the product with the rear handle facing upwards.

3. Flush the air intakes at the rear handle with clean water. The water will run out through the front air outlets.
4. Connect the plug and operate the engine dry for approximately 30 seconds in order to increase the speed of drying the engine.

To clean the cooling air intake

The product has a fan to let the temperature of the motor decrease. Operate the rear handle of the product to absorb the cooling air through the grille. The air can pass over the stator and rotor and out through the front of the motor housing.

1. Always keep the cooling air openings clear and clean to cool the product sufficiently.

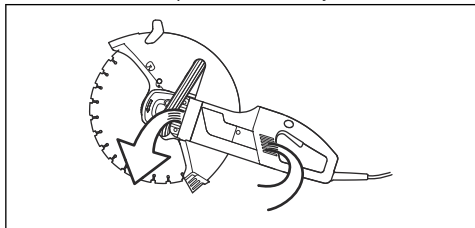

2. Blow the compressed air regularly into the product.

Functional inspections

To do a general function inspection



WARNING: Never use damaged cables. They can cause serious, even fatal, personal injuries.

1. Make sure the cord and extension cord are intact and in good condition. Never use the product if the cord is damaged, you must hand it to an approved service workshop for repair.
2. Make sure the nuts and screws are tight.

To inspect the water delivery system

1. Check the nozzles on the blade guard are not clogged.
2. Clean as necessary.
3. Check that the filter on the water connector is not clogged.
4. Clean as necessary.

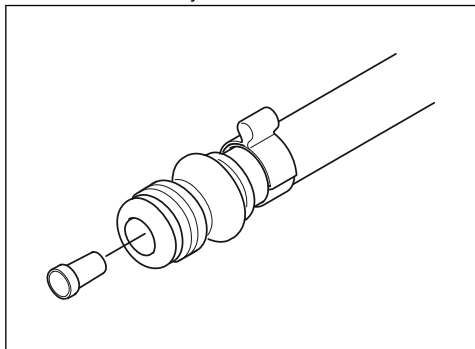

To replace the carbon brushes

Replace the carbon brushes if they are worn, cracked or in any other way damaged. Replace all carbon brushes at the same time.

1. Loosen both screws (A) and (B) to remove the inspection cover.

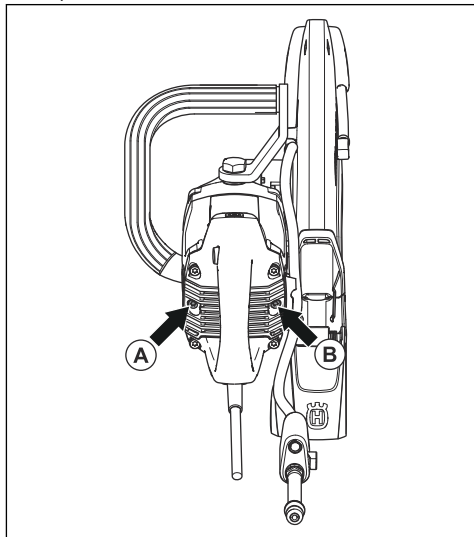

2. Remove the cable that holds the carbon brush.

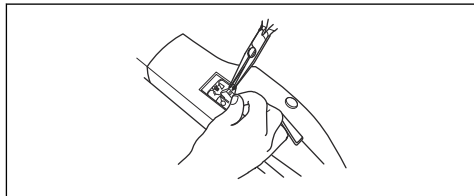

3. Lift the spring and then remove the carbon brush from the brush retainer.
4. Clean the brush retainers with a dry brush.
5. Carefully blow away the dust.
6. Install the new carbon brushes and, at the same time, make sure they slide easily in the brush retainers.
7. Fold down the springs and tighten the cable.
8. Operate the new carbon brushes for approximately 40 minutes while idling.

To fill gearbox grease

Do not fill the gear housing fully with grease. The grease expands while the temperature of the product increases during operation. If you fill the gear housing fully with grease, it could cause damage to the seals and leakage of grease.

The gear housing should contain 90 g (0.2 lb) of grease in total. Use only grease that is recommended by Husqvarna.

You must disassemble the parts that follow to replace the grease in the gear housing:

1. Disassemble the flange washers that hold the cutting blade.

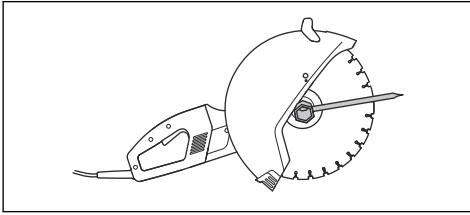

2. Disassemble the sealing ring.
3. Disassemble the support flange for the guard.

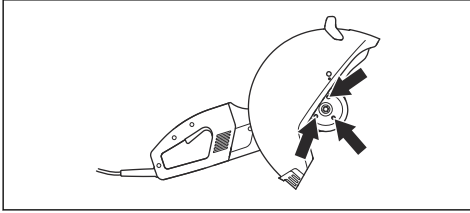

4. Disassemble the blade guard.

5. Remove the four screws that hold the shield.

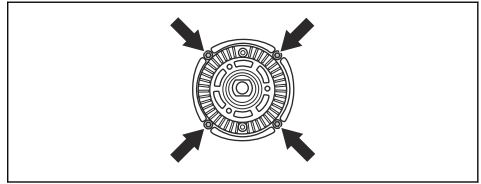

6. Lift the shield together with the drive wheel unit out of the gear housing.

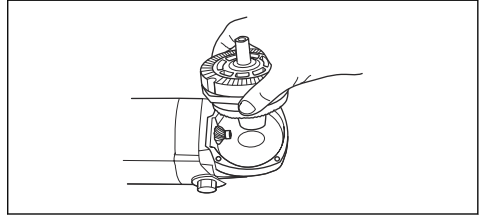

7. Wipe out the grease and fill the gear housing with new and good quality gear grease.

TRANSPORTATION, STORAGE AND DISPOSAL

Transportation

Transportation of product

- Secure the product during transportation in order to avoid transport damage and accidents.

Transportation of cutting blades

- Do not transport the power cutter with the cutting blade fitted. Remove all the cutting blades from the power cutter after use.
- Inspect new blades for transport damage.

Storage

Storage of the product

- Store the product in a lockable area so that it is out of reach of children and unauthorized persons.

Storage of cutting blades

- Do not store the power cutter with the cutting blade fitted. Remove all the cutting blades from the power cutter after use and stored them carefully.
- Store the cutting blades in dry, frost free conditions. Take special care of the abrasive blades. The abrasive blades must be stored on a flat, level surface. If an abrasive blade is stored in humid

conditions, this can cause imbalance and result in injury.

- Inspect new blades for storage damage.

Disposal

Symbols on the product or the packaging of the product indicate that this product cannot be handled as domestic waste. It must be submitted to an appropriate recycling station for the recovery of electrical and electronic equipment.

By ensuring that this product is taken care of correctly, you can help to counteract the potential negative impact on the environment and people that can otherwise result through the incorrect waste management of this product. For more detailed information about recycling this product, contact your municipality, your domestic waste service or the shop from where you purchased the product.

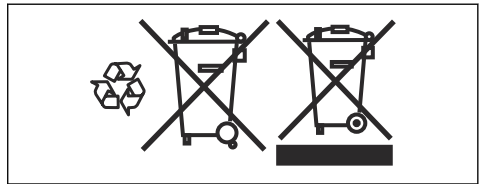

TECHNICAL DATA

Technical data

K 4000		
Protection class		I
Max. speed of output shaft, rpm	120V, 60Hz	3400
	230V, 50Hz	3600
Rated voltage, V		
Europe		230
United Kingdom and Ireland		110
USA / Canada / Japan		100-120
Australia		230
Rated output, W		
Europe	230V, 50Hz	2700/12 A
United Kingdom and Ireland	110V, 50Hz	2200/20 A
USA / Canada / Japan	100-120V, 50-60Hz	15 A
Australia	230V, 50Hz	2300/10 A
Weight		
Machine without cable package, without blade and Vac attachment, kg (lbs)		7.6 (16.7)
Water cooling		
Water cooling of blade		Yes
Connecting nipple		Type "Gardena"
Recommended water pressure, bar (PSI)		0.5-8 (7.3-116)
Noise emissions (see Note 1)		
Sound power level, measured dB (A)		104
Sound power level, guaranteed L _{WA} dB (A)		105
Sound levels (see Note 2)		
Equivalent sound pressure level at the operator's ear, dB (A)		95
Equivalent vibration levels, a_{hveq} (see Note 3)		
Front handle, m/s ²		3.5
Rear handle, m/s ²		3.5

K 4000

Note 1: Noise emissions in the environment measured as sound power (LWA) in conformity with directive 2000/14/EC. The difference between guaranteed and measured sound power is that the guaranteed sound power also includes dispersion in the measurement result and the variations between different products of the same model according to directive 2000/14/EC.

Note 2: Equivalent sound pressure level, according to EN ISO 19432, is calculated as the time-weighted energy total for different sound pressure levels under various working conditions. Reported data for equivalent sound pressure level for the product has a typical statistical dispersion (standard deviation) of 1 dB (A).

Note 3: Equivalent vibration level, according to EN ISO 19432, is calculated as the time-weighted energy total for vibration levels under various working conditions. Reported data for equivalent vibration level has a typical statistical dispersion (standard deviation) of 1 m/s².

Recommended abrasive and diamond cutting blade

Cutting blade, mm (inch)	350 (14)
Max. peripheral speed, m/s (ft/s)	100 (19600)
Max. blade speed, rpm	3900
Max. cutting depth, mm (inch)	125 (4 59/64)
Max. cutting depth with the Vac attachment, mm (inch)	119 (4 11/16)



CAUTION: The below recommendations apply to minimum cable area relative to the maximum extension cable. Follow the recommendations to avoid impaired performance and damage to the product.

Cable area	1,5 mm ²	2,5 mm ²
Input voltage 100-120 V	20 m	40 m
Input voltage 220-240 V	30 m	50 m

EC DECLARATION OF CONFORMITY

EC Declaration of Conformity

(Applies to Europe only)

Husqvarna AB, SE-561 82 Huskvarna, Sweden, tel: +46-36-146500, declares under sole responsibility that the power cutter **Husqvarna K 4000** dating from 2018 serial numbers and onward (the year is clearly stated on the type plate, followed by the serial number), complies with the requirements of the COUNCIL'S DIRECTIVE:

- of May 17, 2006 "relating to machinery" **2006/42/EC**.
- of February 26, 2014 "relating to electromagnetic compatibility" **2014/30/EU**.
- of June 8, 2011 on the "restriction of use of certain hazardous substances" **2011/65/EU**.

The following standards have been applied: **EN ISO 12100:2010, EN 55014-1:2006+A1:2009+A2:2011, EN 55014-2:1997+A1:2001+A2:2008, EN 61000-3-2:2014, EN 61000-3-3:2013, EN 60745-1:2009, EN 60745-2-22:2011+A11:2013.**

Partille, 1 January 2018

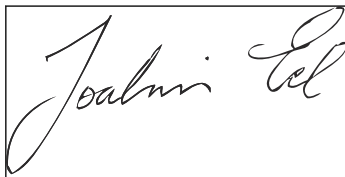
A rectangular box containing a handwritten signature in black ink. The signature is written in a cursive style and appears to read "Joakim Ed".

Joakim Ed

Global R&D Director

Construction Equipment Husqvarna AB

(Authorized representative for Husqvarna AB and responsible for technical documentation.)